

The WellGood active loop antenna tested in combination with the Airspy HF+ SDR

Matthias DD1US, Updated March 6th 2022

I was always interested in active loop antennas, especially for portable operations. However, commercial antennas are rather expensive. When I found the excellent description of the WellGood loop on George Smart's website, I immediately decided to build such an antenna. Fortunately, George MIGEO was kind enough to provide the PCBs for very reasonable cost and thus I started this little project. His design is derived from the well know WellBrook-Loop model ALA1530. Here is the schematic George is providing on his website at https://www.george-smart.co.uk/projects/wellgood_loop/ together with detailed instructions how to build it:

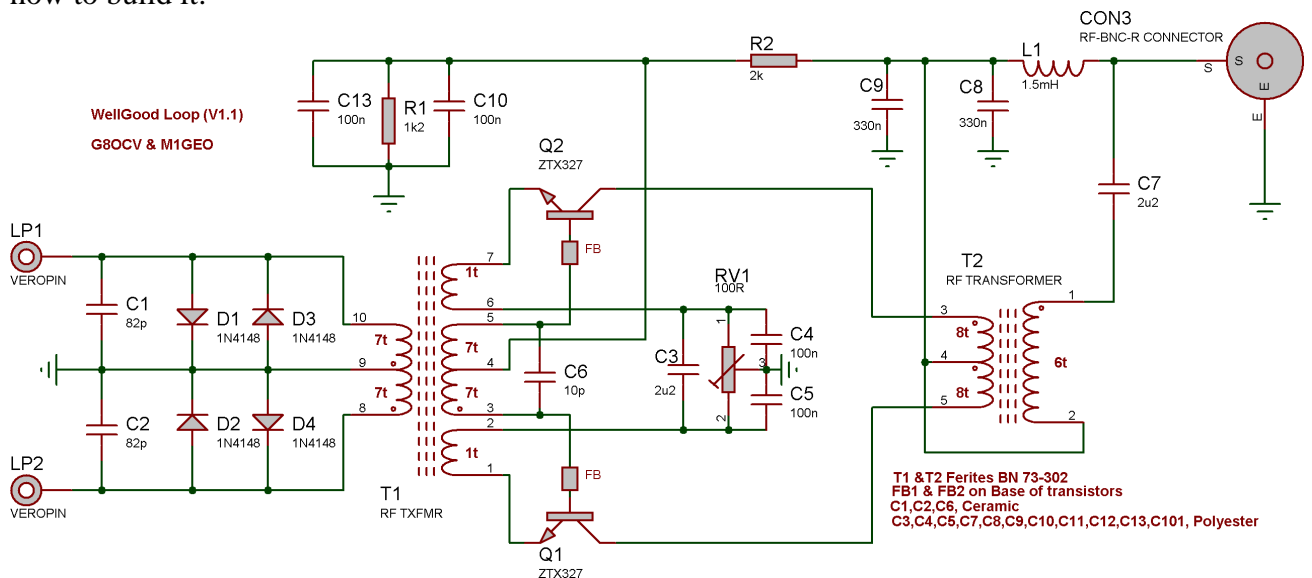

Update April 1st 2021:

A friendly OM who tried to build the antenna pointed out, that there is a mistake in the description on how to wind the RF transformer T1. I created a corrected winding diagram which you can find below:

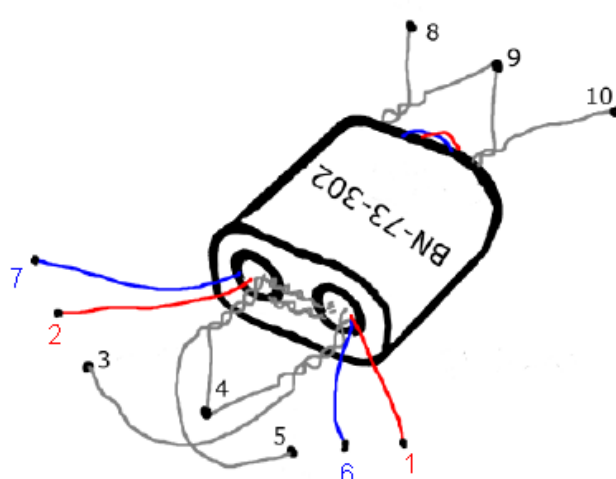

I wanted to build a portable antenna, which can be quickly assembled respectively disassembled and stowed away with minimum space requirements. Searching for suitable material I found some coaxial jumper cables in my storage. The two coaxial cables of the type “HFSC 12D LS” are each 1m long and feature high quality N connectors on each end. They are 1/2” cables, but quite flexible and lightweight and the resulting loop diameter is 66cm. The cables feature a copper clad aluminium conductor with a diameter of 3.6mm, a foamed polyethylene dielectric and a corrugated copper metallic shield.

I decided to build a shielded antenna in order to minimize the sensitivity of the loop antenna to local noise sources. A good read is “A Practical Approach To Building and Evaluating a Broadband Active Loop Antenna, looking at the Mobius, Conventional Shielded and Wire Loops” from Everett Sharp N8CNP. In order to potentially also test the Moebius Loop configuration in the future I decided for a flexible, yet water-proof setup shown on the subsequent pictures.

The setup also includes a linear regulated 12V power supply and Bias-T to provide a phantom feed of the supply voltage to the active antenna via the coaxial cable.



This is the finished loop antenna with the V2A mast clamp.



This is the aluminium box housing the amplifier electronics.



The 10mm Plexiglas rod stabilizes the loop. Later I replaced the 10mm rod with more rigid rod with a diameter of 15mm.



This isolating plastic box provides the mechanical connections of the coaxial cables and the Plexiglas rod...



... as well as the connection of the inner conductors of the coaxial cables.

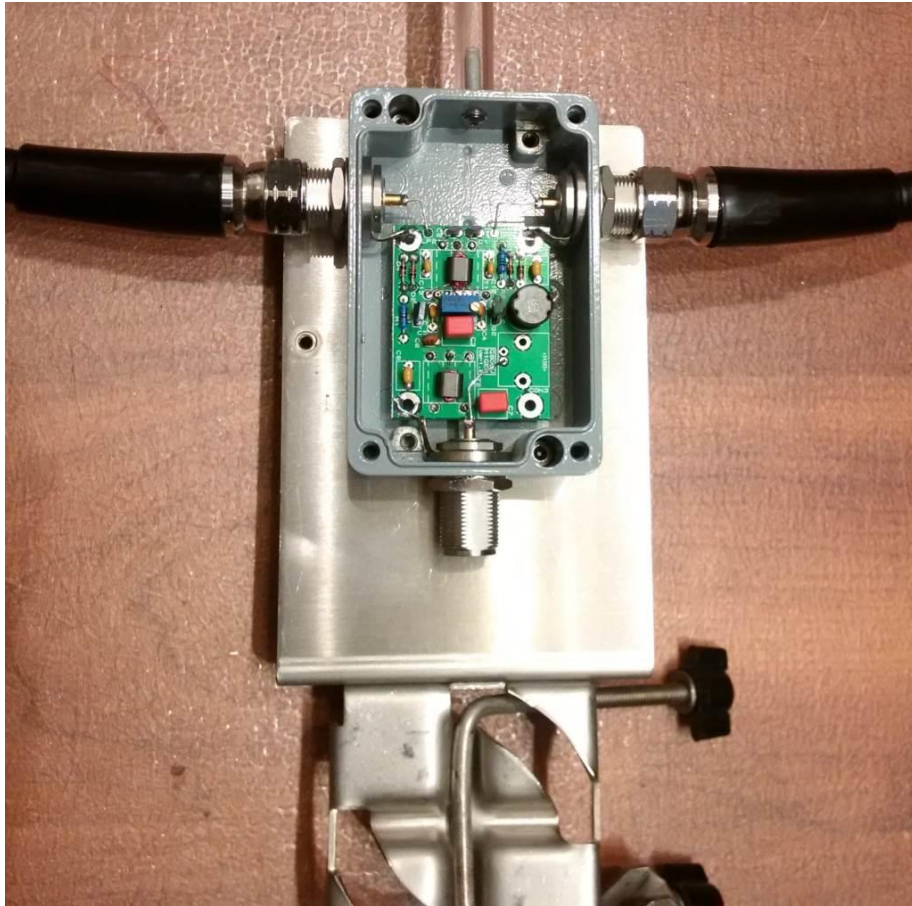

All connections are N-connectors. The shield is provided by the metal box.



The aluminium box is waterproof.



This is the 12V power supply and the Bias-T. The power supply is using a 7812V linear voltage regulator IC to avoid any interference.



The plastic box of the power supply is also waterproof.

The Bias-T is built into a surplus encasing with N-connectors at input and output. It can be connected to the receiver either with a coaxial cable or the N-to-SMA adapter as shown below. For the connection from the Bias-T to the antenna even a longer RG58 cable can be used, as the signal is already amplified at the antenna and therefore cable losses are no problem.

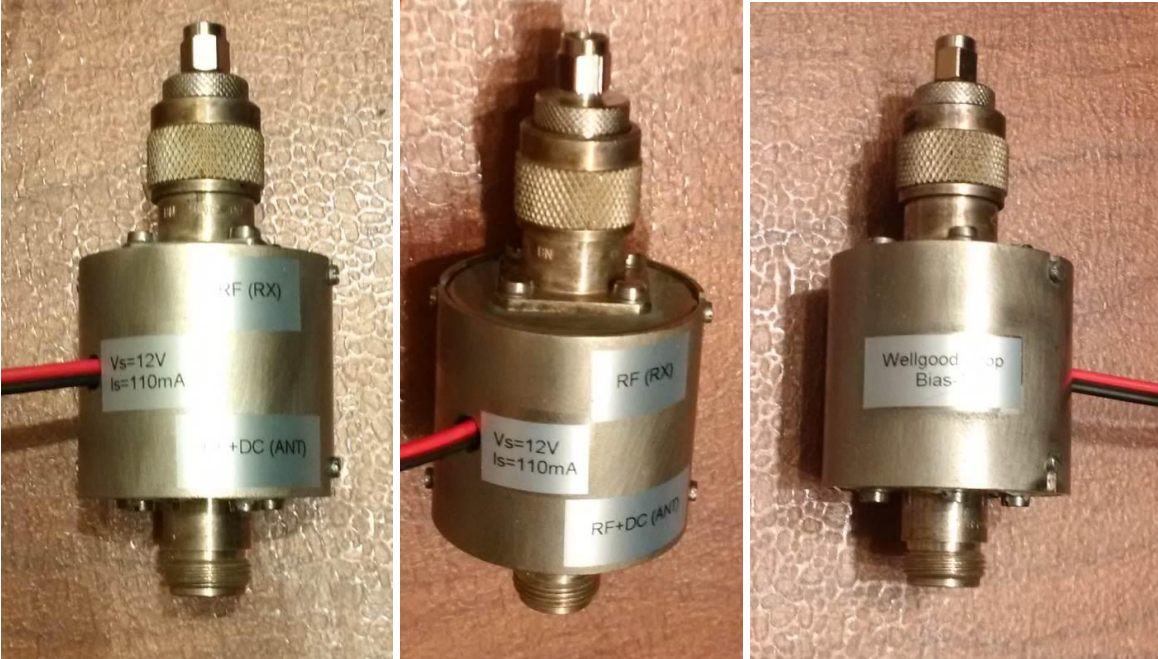

For the test of the active loop antenna I used an Airspy HF+ SDR which I recently bought.

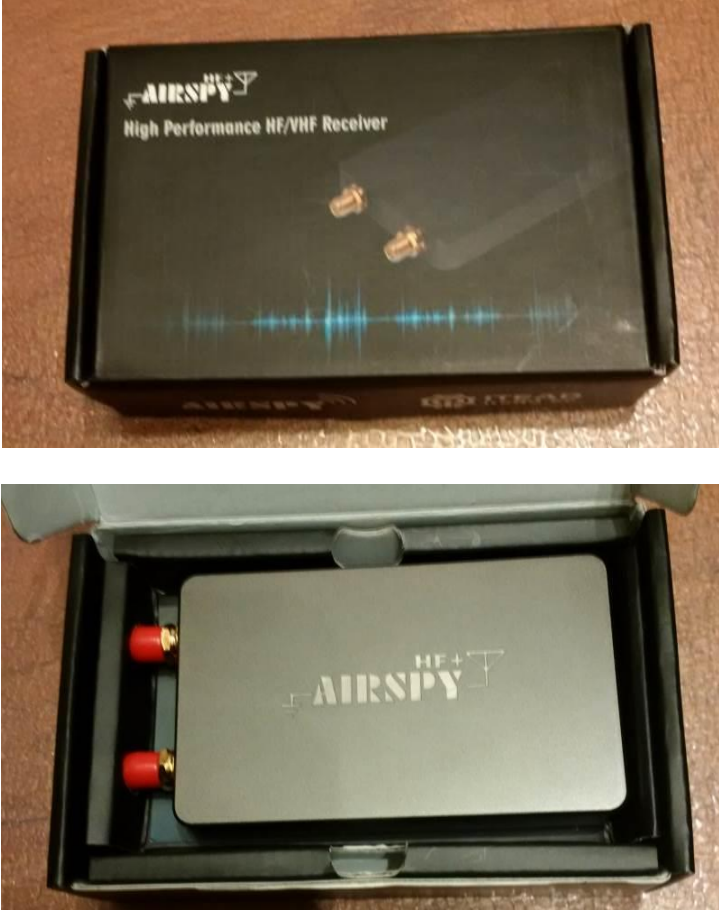

Last Sunday I made use of a warm and sunny day and tested the WellGood antenna together with the Airspy HF+ in my garden. Here are some pictures of the setup:



The WellGood Loop antenna was mounted approximately 2m high.

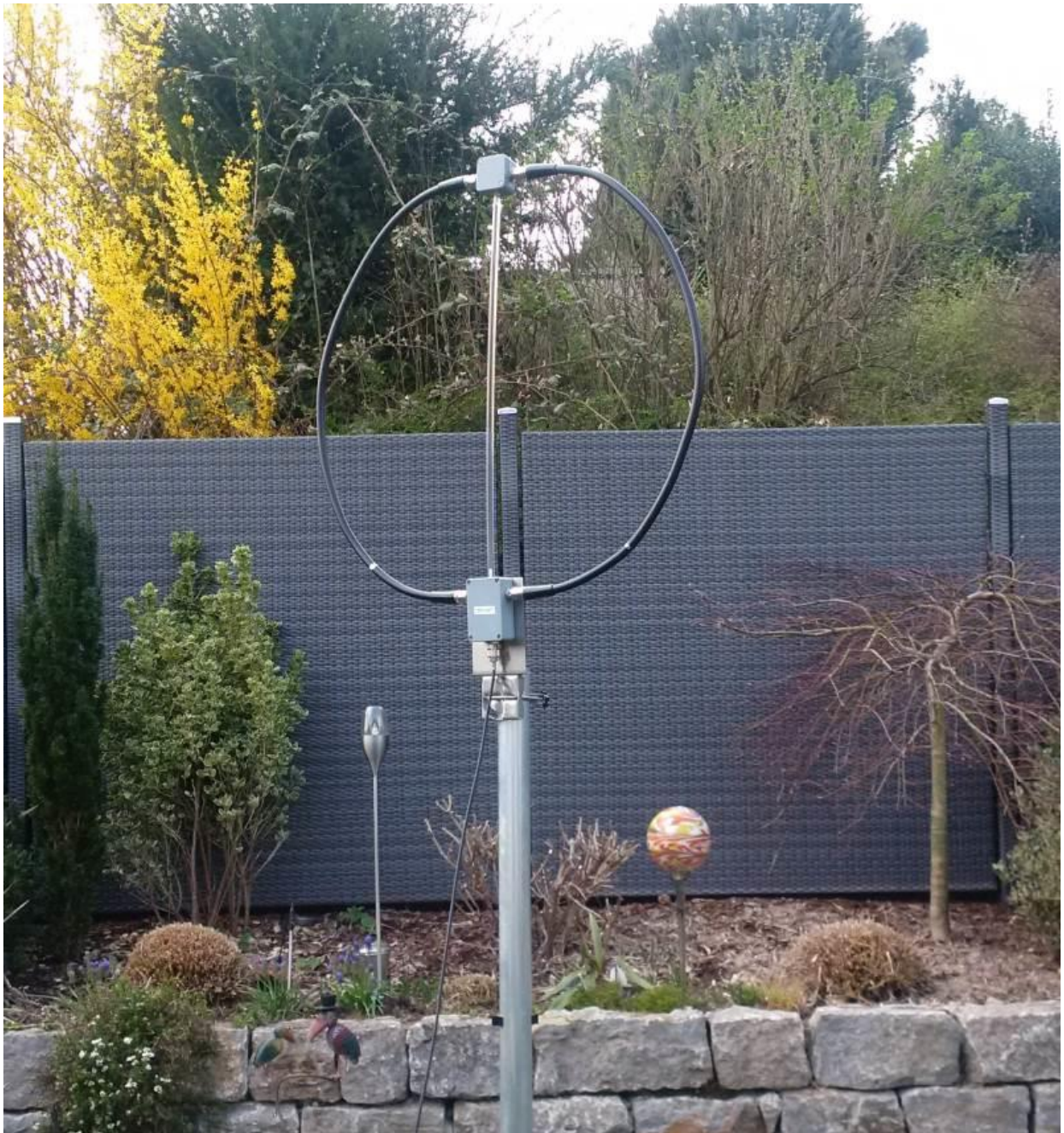

I used an already available aluminium post which normally holds the dartboard 😊





The laptop is running SDR# in combination with the Airspy HF+ SDR

When initially testing this setup, I recognized a high interference level, which was quickly identified to be caused by the power supply of the laptop.

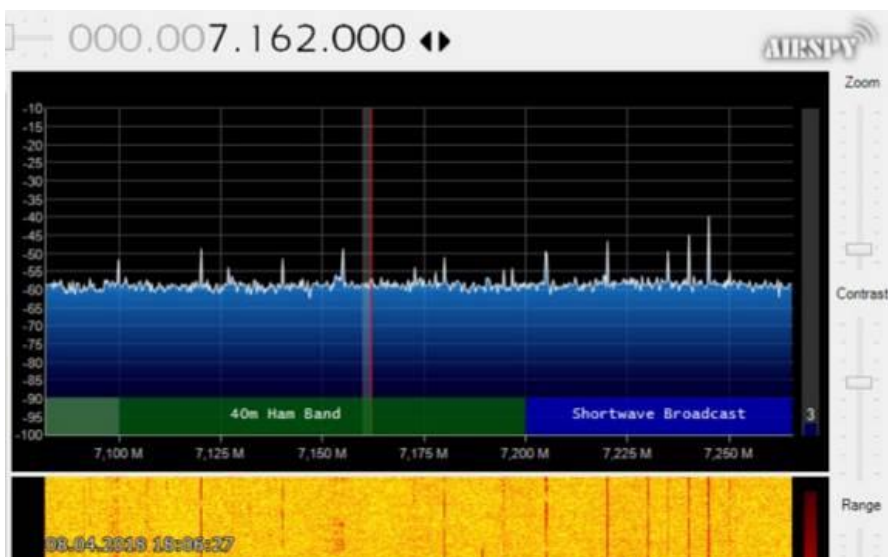

I tried to reduce the noise level by winding the DC output cable of the power supply through a ferrite choke.



The choke reduced the interference level significantly, but did not remove it completely.

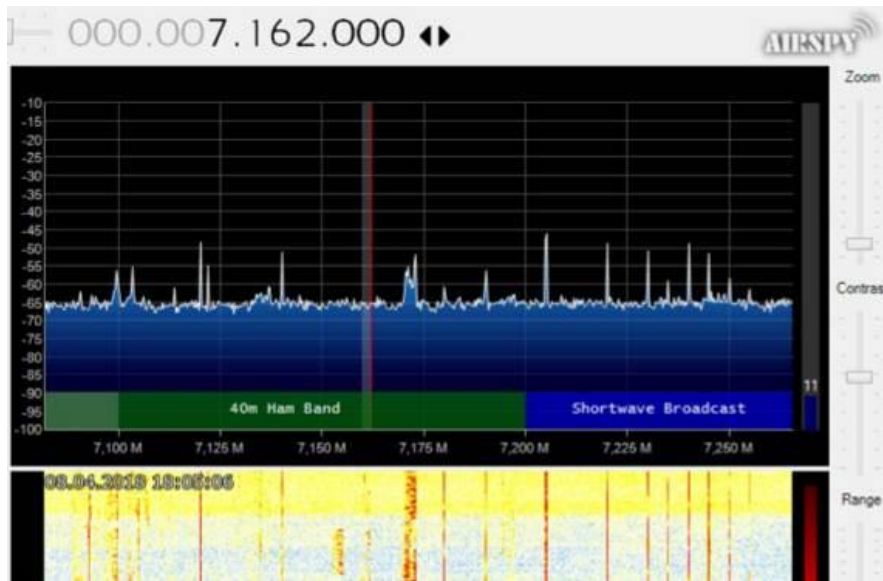

Thus, I ended up running the laptop from its batteries which gave the best results.

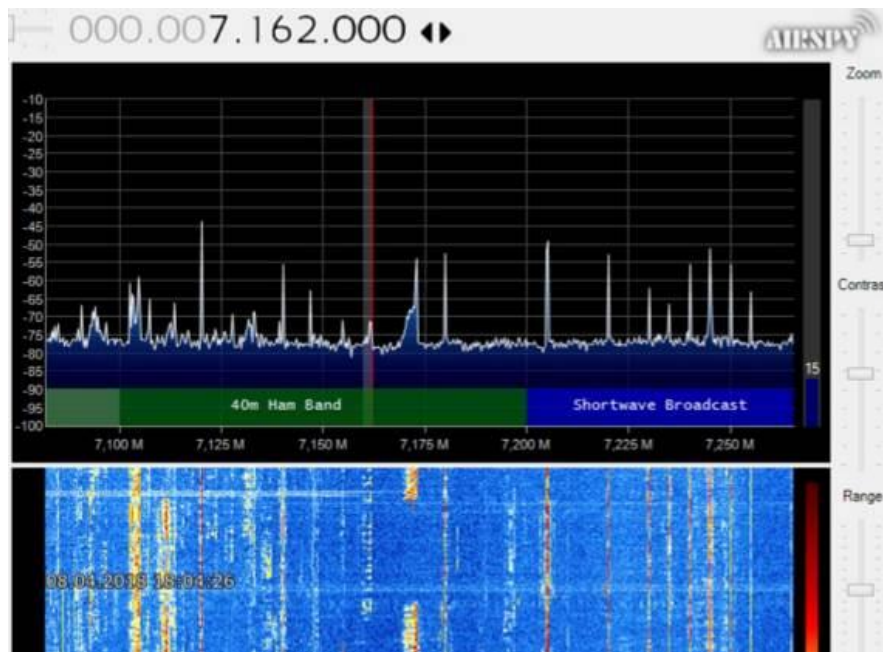

Next, I tested the WellGood Loop Antenna on different bands. A good loop construction should provide rather sharp nulls in the directivity antenna diagram.

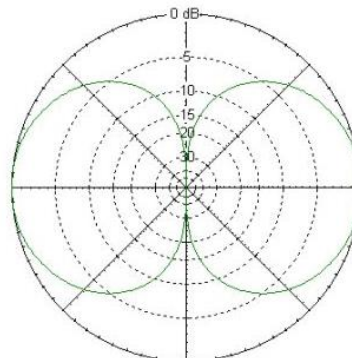

I started with one of the strongest signals, which is a radio-beacon signal on 337 kHz. This station is about 30km North from my location. I first maximized and then minimized the signal strength by rotating the loop antenna. As you can see, the difference is approx. 25dB.

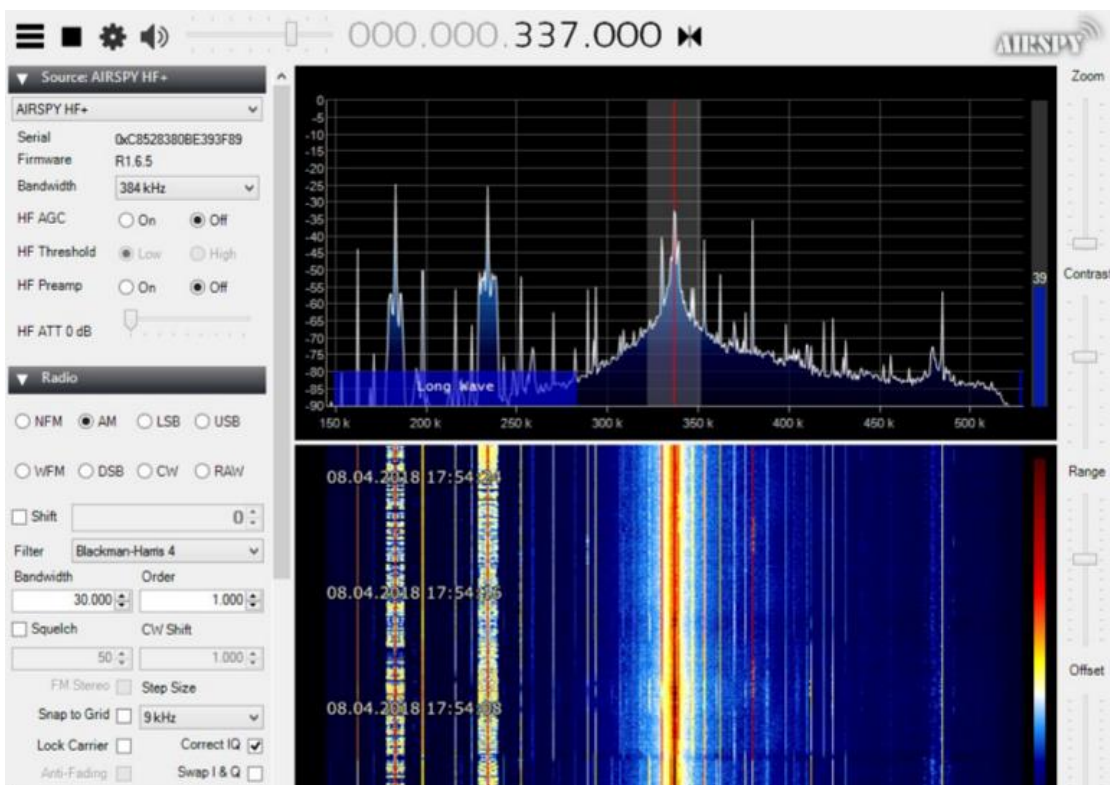
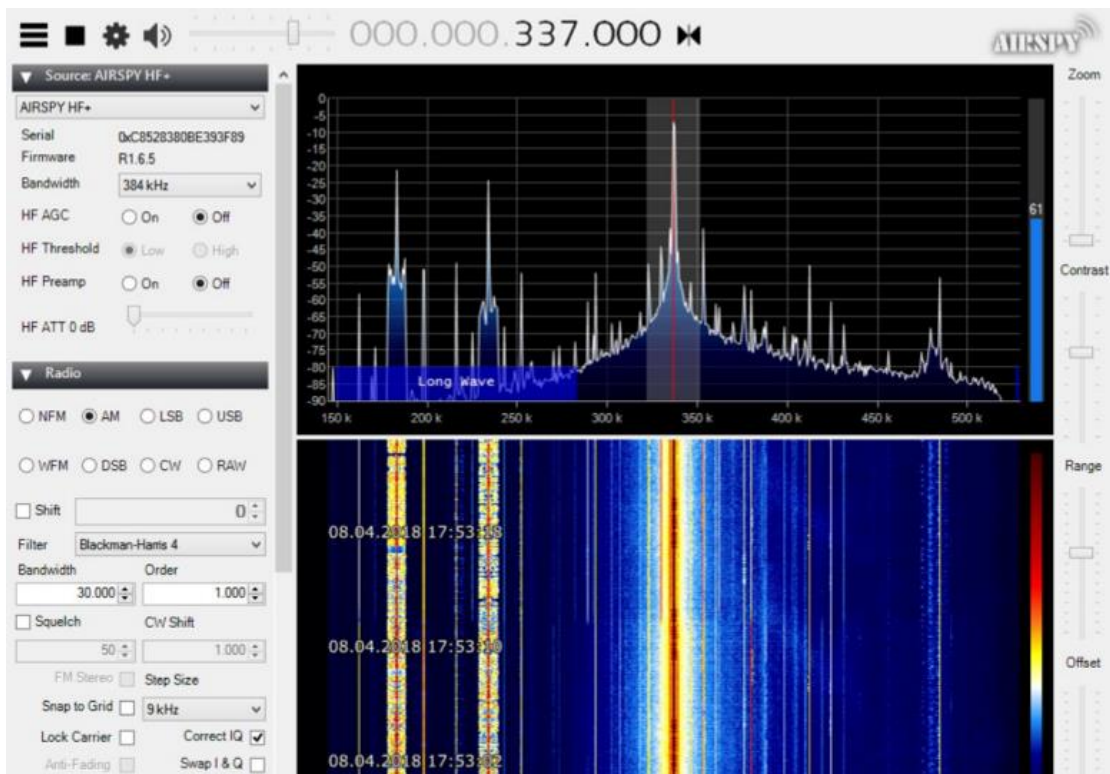

Then I checked some longwave broadcast stations around 183kHz. Here I also checked the symmetry of the loop characteristic. The first picture shows the signals, when the antenna is pointing to southwest.

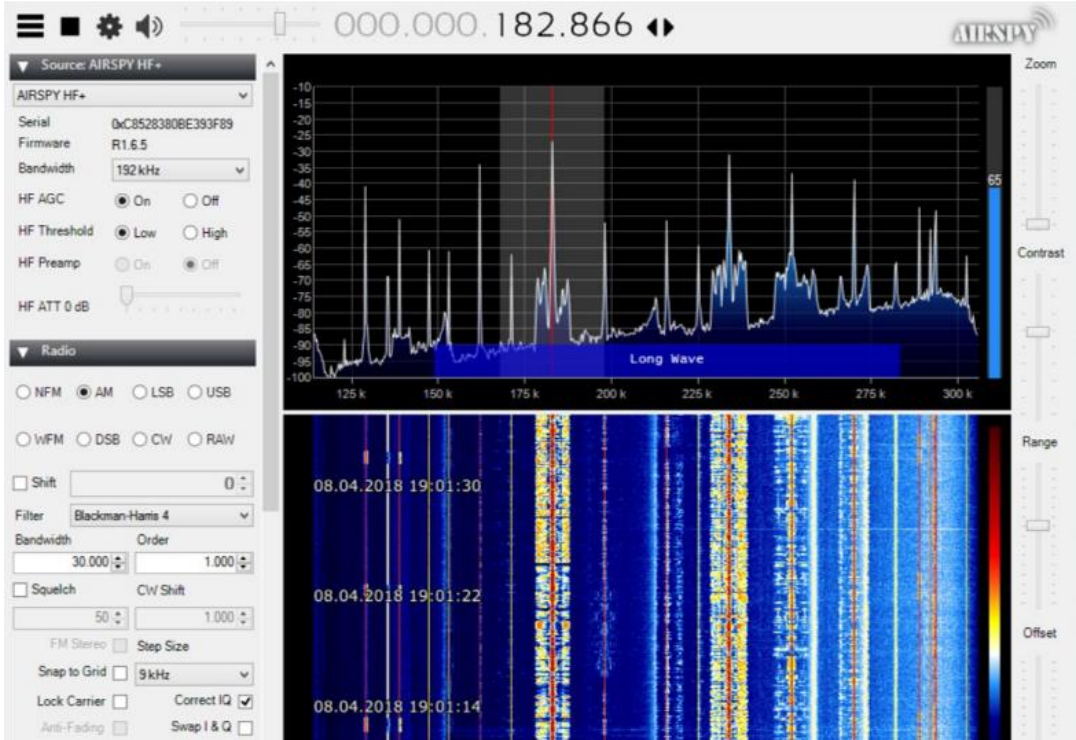

I then turned the antenna to southeast and the signal increased by approx. 15dB.

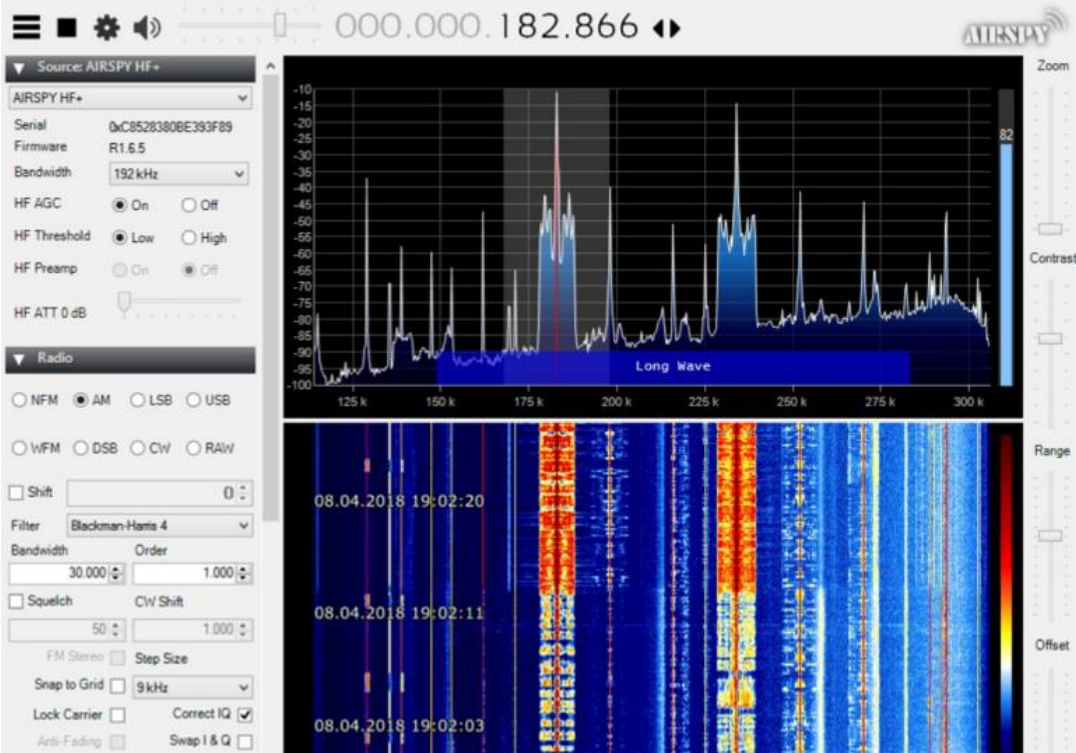

In the waterfall diagram above you can see clearly the effect of the signal increasing when turning the antenna from southwest to southeast.

Next, I turned the antenna to northeast. As expected the signal is almost identical to the case where the antenna was pointing southwest, i.e. 180 degrees in the opposite direction.

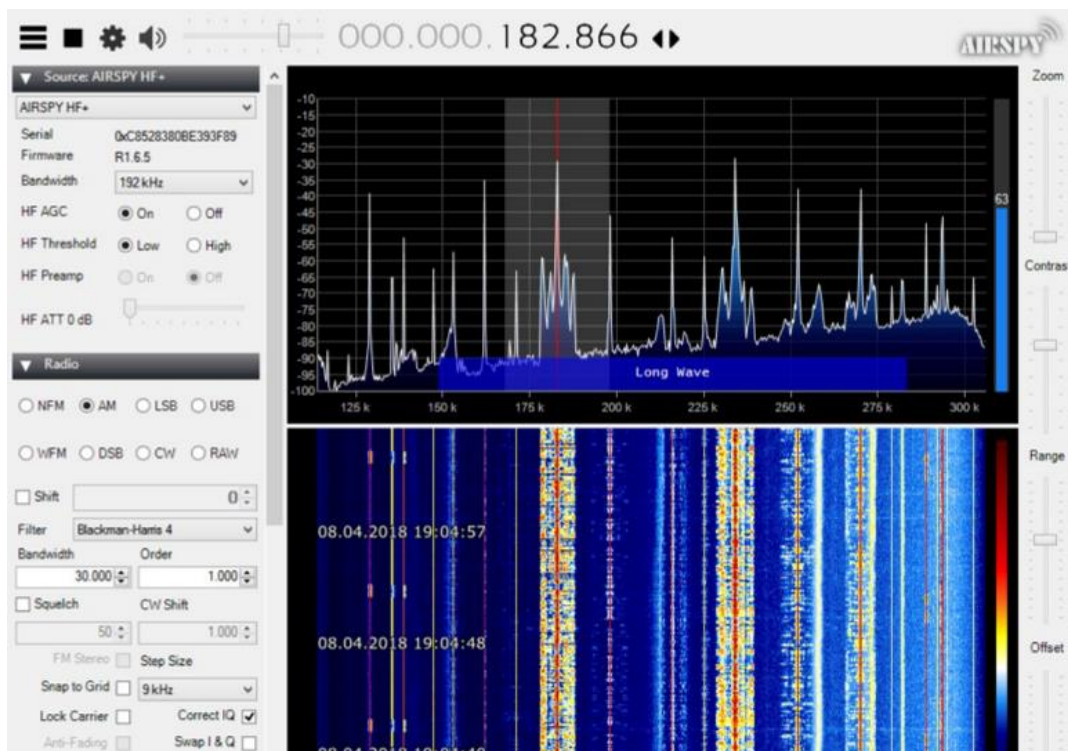

Finally, I turned the loop from northeast to northwest and the signal increased by approx. 18dB.

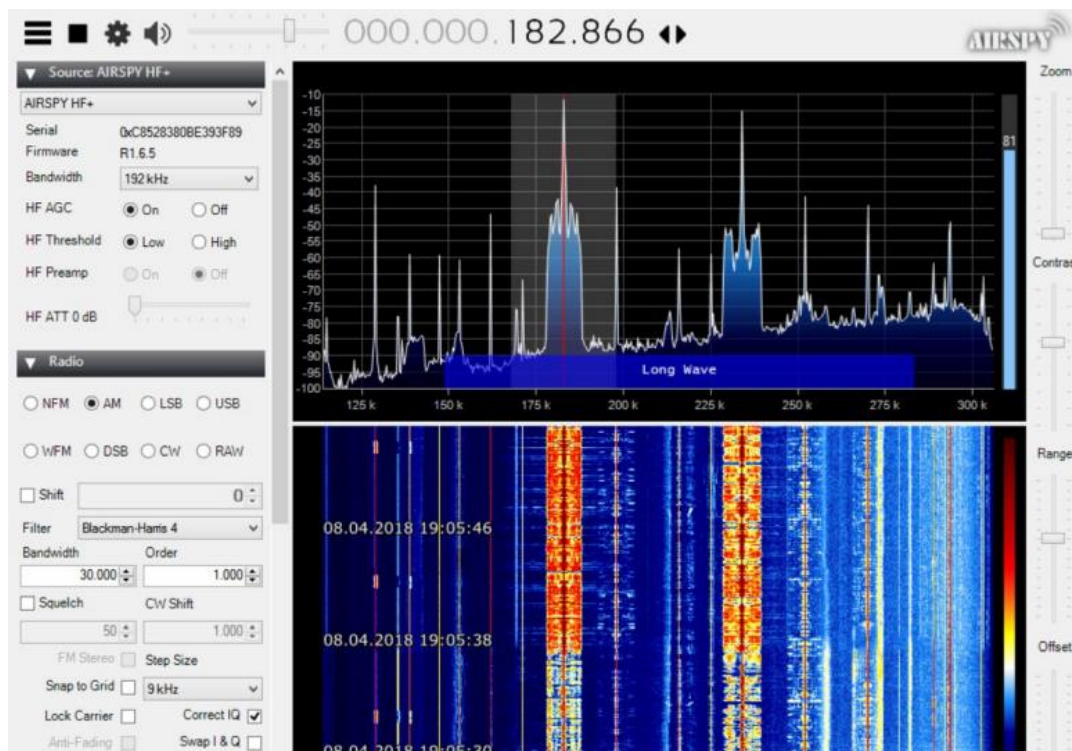

Then I checked the loop performance on different ham radio bands. Below you will find some spectrum and waterfall pictures gathered on 20m, 40m, 80m and 160m bands.

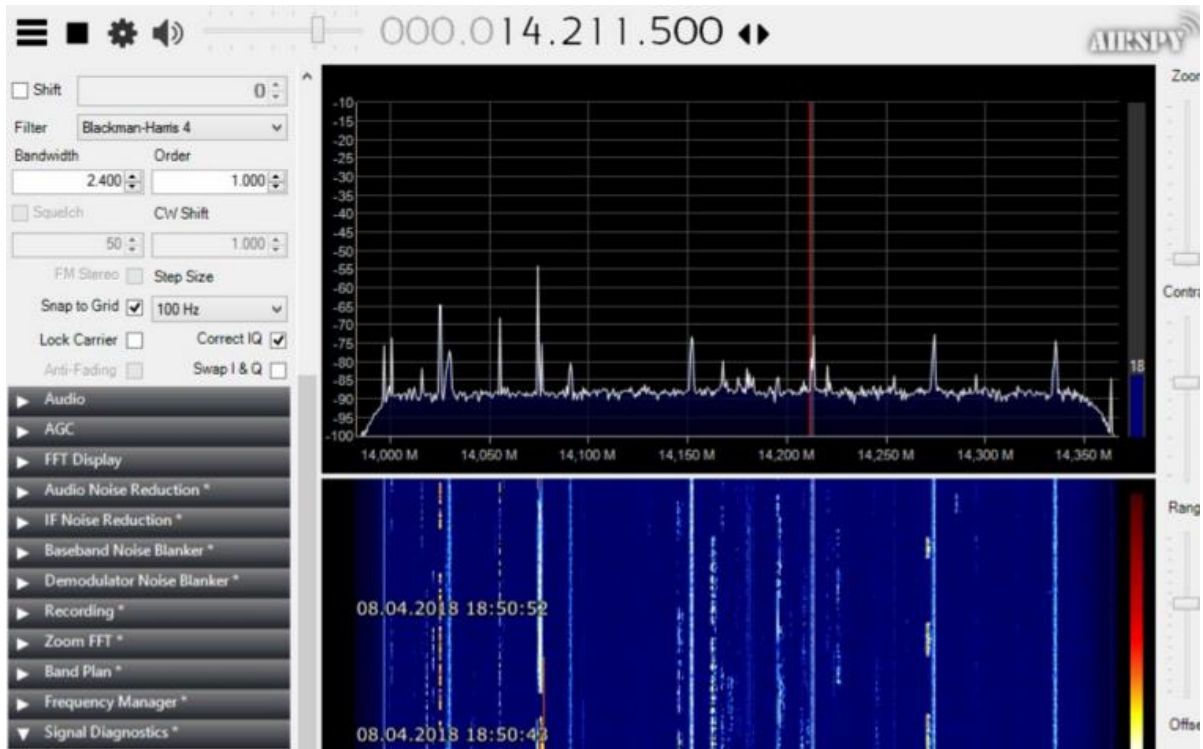

I compared the loop antenna with my active HF vertical whip antenna R&S HE010, which is located on top of my house and the signal levels and SNRs were roughly equivalent.

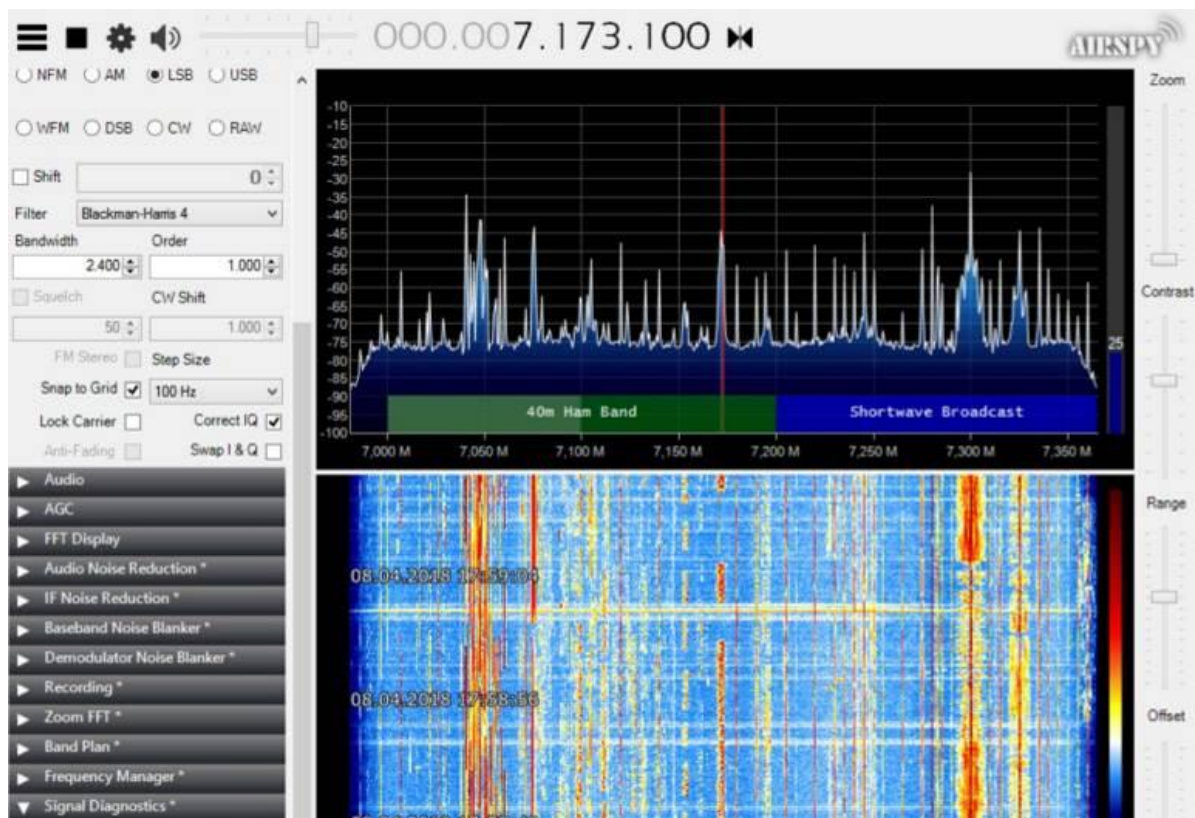

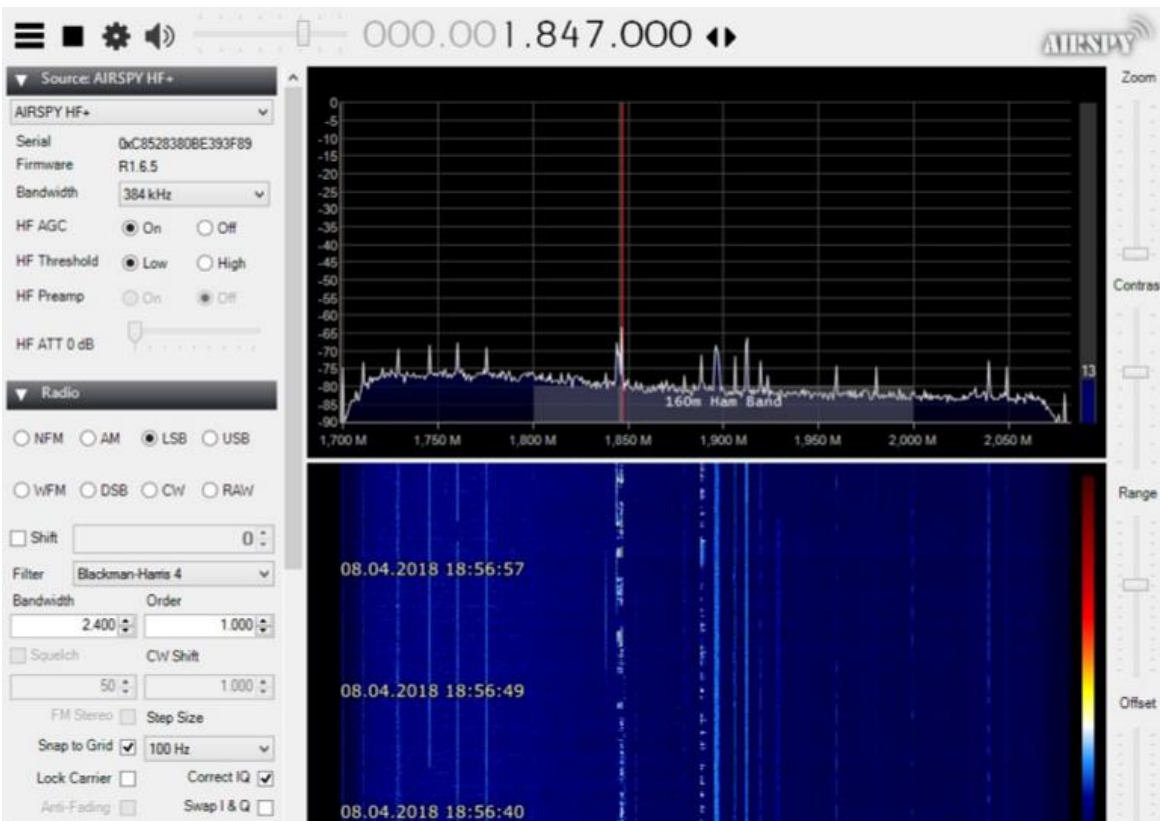
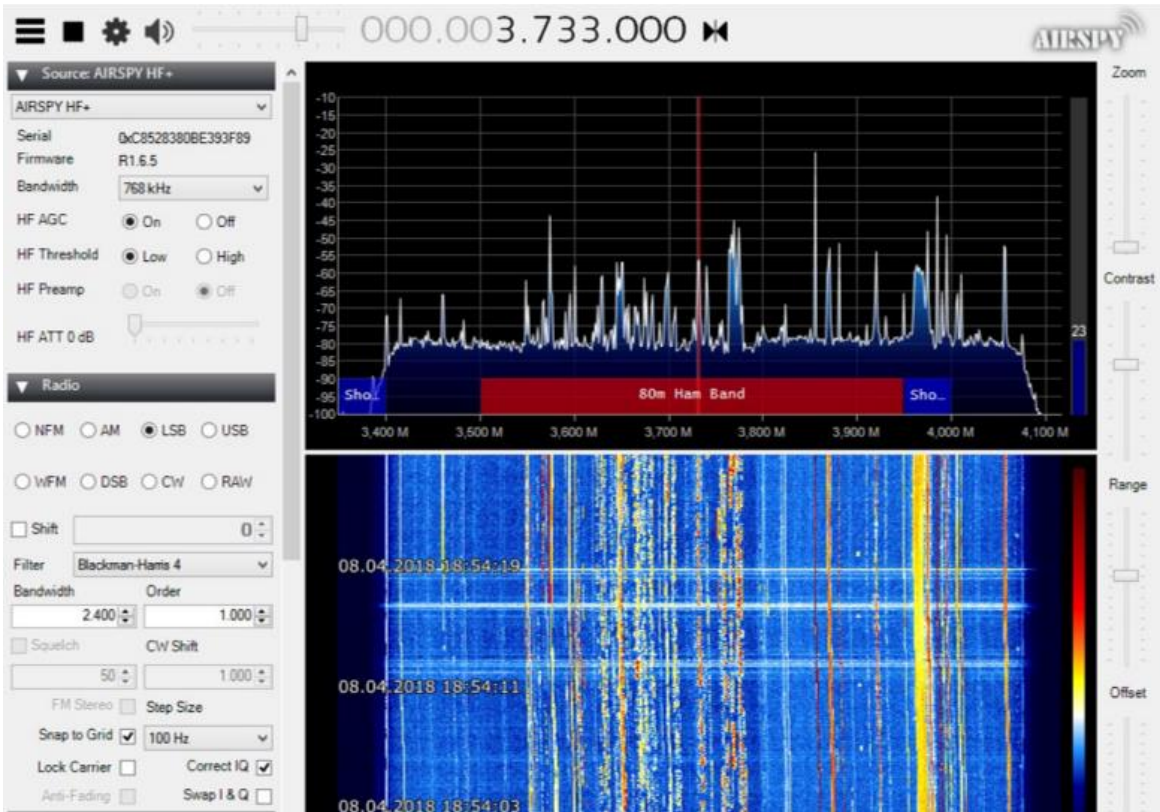

I got a number of Emails asking how well the Wellgood antenna works compared to other antennas. I have not done such a 1:1 comparison but Roland HB9VQQ was kind enough to send me his data and allow me to include it in this description. Roland compared his Wellgood magnetic loop antenna to an End Fed Half Wave (EFHW) wire-antenna.

Here is a picture of his Wellgood antenna:



Here is a sketch of his EFFHW wireantenna:

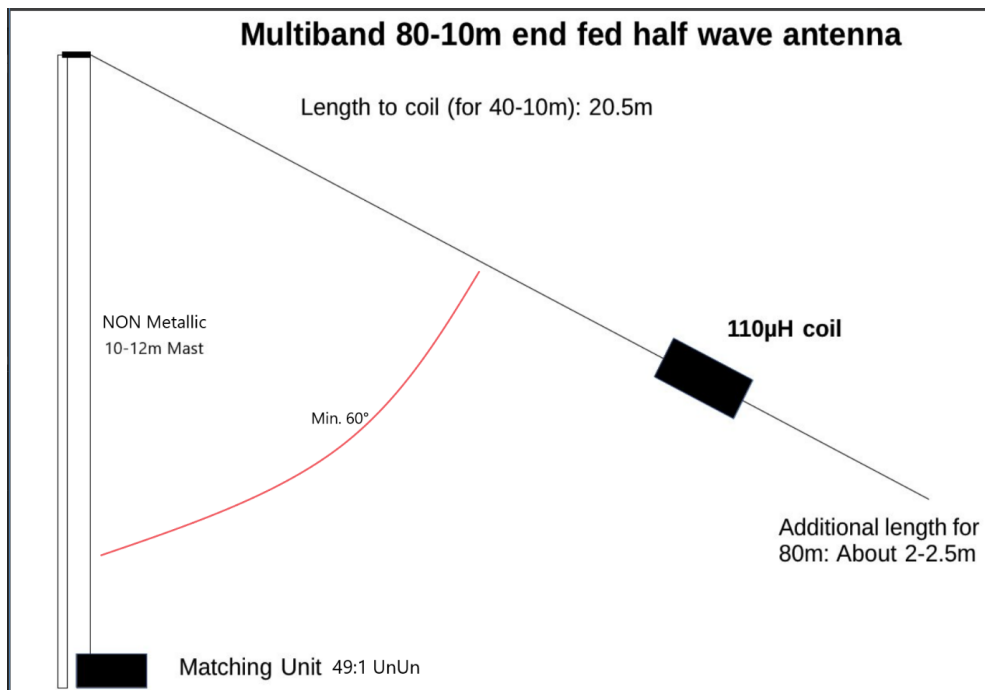

He compared the spots recorded with each antenna within 46h against each other:

Antenna	Raw Spots	Antenna	Unique Spots								
EFHW	4969	EFHW	675								
Wellgood	4054 (82%)	Wellgood	560 (83%)								
Unique Spots	<u>160m</u>	<u>80m</u>	<u>60m</u>	<u>40m</u>	<u>30m</u>	<u>20m</u>	<u>17m</u>	<u>15m</u>	<u>12m</u>	<u>10m</u>	
EFHW	26	91	12	199	118	128	40	41	11	19	
Wellgood	30	90	13	188	94	99	25	14	4	3	
Gross Spots	<u>160m</u>	<u>80m</u>	<u>60m</u>	<u>40m</u>	<u>30m</u>	<u>20m</u>	<u>17m</u>	<u>15m</u>	<u>12m</u>	<u>10m</u>	
EFHW	256	1115	101	1530	847	598	234	187	66	35	
Wellgood	284	991	107	1333	605	469	150	74	31	10	
Avg SNR dB	<u>160m</u>	<u>80m</u>	<u>60m</u>	<u>40m</u>	<u>30m</u>	<u>20m</u>	<u>17m</u>	<u>15m</u>	<u>12m</u>	<u>10m</u>	
EFHW	-15	-15	-17	-15	-15	-16	-18	-17	-15	-17	
Wellgood	-12	-16	-17	-15	-15	-17	-19	-14	-17	-21	
Avg Distance km	<u>160m</u>	<u>80m</u>	<u>60m</u>	<u>40m</u>	<u>30m</u>	<u>20m</u>	<u>17m</u>	<u>15m</u>	<u>12m</u>	<u>10m</u>	
EFHW	644	697	1232	2297	2698	3890	5113	4566	3962	3408	
Wellgood	640	742	1222	2043	1801	3120	4398	3448	2929	2463	
Prepared by HB9VQQ			30.January 2022								

While the Wellgood-Loop was doing quite well on the lower Bands the EFHW wins with both, the total number of Spots and DX Spots where the distance is >3000km. Roland suggests that the solid performance of the Loop on the lower Bands is probably one reason why this Antenna is very common among the BCL SWL community on LF and MF. The other reason is probably that the Loop is very compact (diameter 0,65m, wire length 2m) versus the length of the wire of the EFHW antenna of 23m.

Thank you very much to Roland HB9VQQ for kindly sharing his results with us.

I am always happy to answer questions. Please direct them to my Email address given below.

Best regards

Matthias Email: dd1us@amsat.org

Homepage: www.dd1us.de